

MAXTECH

UAR080x38-Ø12 HL44,4 grey

EAN 4031582323085

Telo tocka od poliamida, Omotac> Poliuretan, valjkasti lezaj



BETTER MOBILITY. BETTER LIFE.



Picture may differ from original product

Tehnicki podaci

Precnik tocka.	80 mm
Sirina gazista.	38 mm
Otvor za osovinu Ø	12 mm
Duzina glavcine.	44.4 mm
Temperatura	- 25 / + 80 °C
Standard	EN 12532
Tezina	0.192 kg
Tvrdoca omotaca	Shore D 42
Dinamicka nosivost.	150 kg
Staticka nosivost.	300 kg

Dimensions

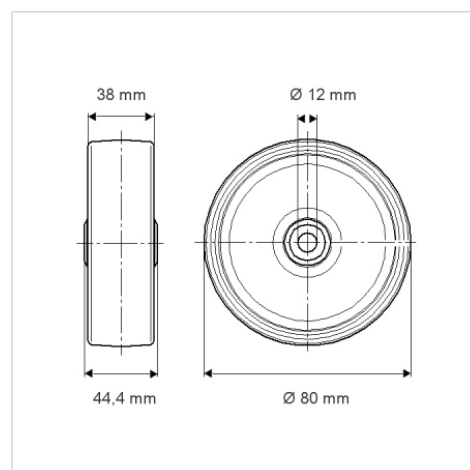

Advantages at a glance

Otpor okretanju	● ● ● ○ ○
Buka pri okretanju	● ● ● ○ ○
trenje , habanje	● ● ● ● ○
zastita od korozije	● ● ● ○ ○