

# MAXTECH

UAR125x32-Ø12 HL44,4 grey

EAN 4031582323146

Hjulfælg: Polyamid, Hjulbane: Polyuretan, rulleleje



BETTER MOBILITY. BETTER LIFE.



Illustrationen kan afvige fra originalen

## Tekniske data

Hjul-Ø	125 mm
Hjulbredde	32 mm
Boring-Ø	12 mm
Navlængde	44.4 mm
Temperaturinterval	- 25 / + 80 °C
Standard	EN 12532
Vægt	0.27 kg
Hjulbane hårdhed	Shore D 42
Belastning (dynamisk)	200 kg
Belastning (statisk)	400 kg

## Dimensioner

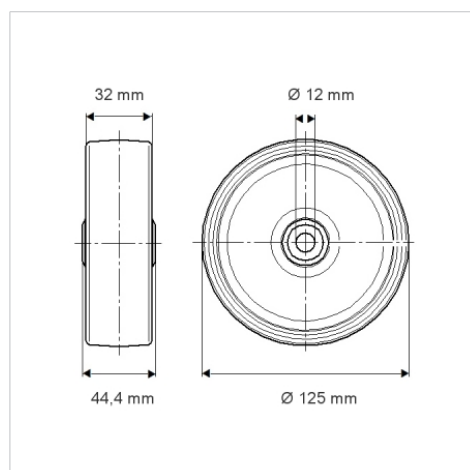

## Egenskaber/fordele

Rullemodstand	● ● ● ○ ○
Kørselsstøj	● ● ● ○ ○
Slid	● ● ● ● ○
Rustbeskyttelse	● ● ● ○ ○