

# MAXTECH

UAR125x38-Ø12 HL44,4 grey

EAN 4031582323160



BETTER MOBILITY. BETTER LIFE.

폴리아미드로 만든 휠 중심, 트레드: 폴리우레탄, 롤러 베어링



Picture may differ from original product

## 기술 데이터

휠 직경	125 mm
휠 폭	38 mm
축 홀-Ø	12 mm
허브 길이	44.4 mm
온도	- 25 / + 80 °C
표준	EN 12532
무게	0.316 kg
트레드 경도	Shore D 42
동하중	300 kg
정지하중	600 kg

## Dimensions

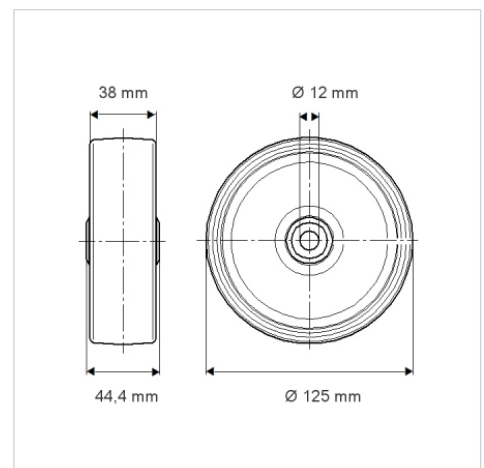

## Advantages at a glance

롤 저항성	● ● ● ○ ○
이동 소음	● ● ● ○ ○
마찰	● ● ● ● ○
부식 방지	● ● ● ○ ○