

ELASTECH

UEP200x46-Ø12

EAN 4031582070378

Wheel center made of Polyamide, Tread: elastic-tire, black, precision ball bearing



BETTER MOBILITY. BETTER LIFE.



Picture may differ from original product

Technical Data

Wheel diameter	200 mm
Wheel width	46 mm
Axle Hole-Ø	12.5 mm
Hub length	60 mm
Temperature	- 20 / + 80 °C
Standard	EN 12532
Weight	1.312 kg
Hardness of tread	Shore A 63
Load capacity (dynamic)	400 kg
Load capacity (static)	800 kg

Dimensions

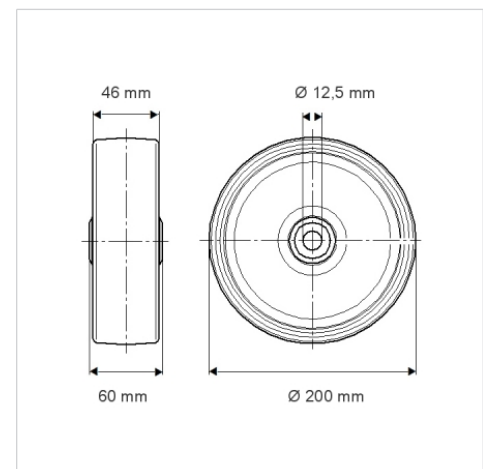

Advantages at a glance

Roll performance	● ● ● ○ ○
Movement noise	● ● ● ● ●
Attrition	● ● ● ○ ○
Corrosion resistance	● ● ● ○ ○