

ELASTECH

UER160x46-Ø20

EAN 4031582323320

Hjulfælg: Polyamid, Hjulbane: Elastisk sort gummi, rulleleje



BETTER MOBILITY. BETTER LIFE.



Illustrationen kan afvige fra originalen

Tekniske data

Hjul-Ø	160 mm
Hjulbredde	46 mm
Boring-Ø	20 mm
Navlængde	58 mm
Temperaturinterval	- 20 / + 80 °C
Standard	EN 12532
Vægt	0.771 kg
Hjulbane hårdhed	Shore A 63
Belastning (dynamisk)	300 kg
Belastning (statisk)	600 kg

Dimensioner

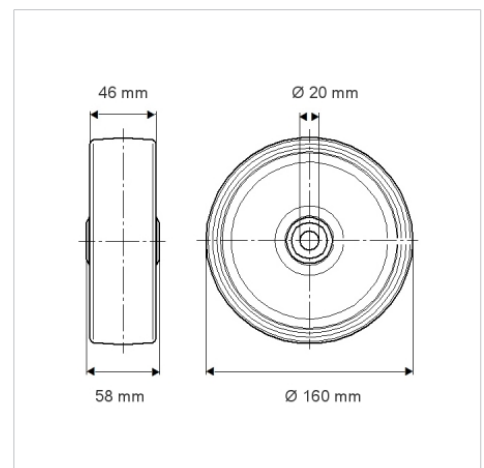

Egenskaber/fordele

Rullemodstand	● ● ● ○ ○
Kørselsstøj	● ● ● ● ●
Slid	● ● ● ○ ○
Rustbeskyttelse	● ● ● ○ ○