

ELASTECH

UER160x46-Ø20

EAN 4031582323320

Wheel centre made of Polyamide, Tread: elastic-tyre, black, roller bearing



BETTER MOBILITY. BETTER LIFE.



Picture may differ from original product

Technical Data

Wheel diameter	160 mm
Wheel width	46 mm
Axle Hole-Ø	20 mm
Hub length	58 mm
Temperature	- 20 / + 80 °C
Standard	EN 12532
Weight	0.771 kg
Hardness of tread	Shore A 63
Load capacity	300 kg
Load capacity (static)	600 kg

Dimensions

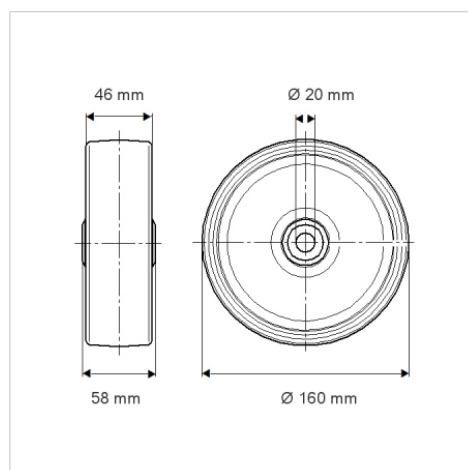

Advantages at a glance

Roll performance	● ● ● ○ ○
Movement noise	● ● ● ● ●
Attrition	● ● ● ○ ○
Corrosion resistance	● ● ● ○ ○