

ELASTECH

UER160x46-Ø20

EAN 4031582323320

Telo tocka od poliamida, Omotac: elasticna guma , crna , valjkasti lezaj

TENTE

BETTER MOBILITY. BETTER LIFE.



Picture may differ from original product

Tehnicki podaci

Precnik tocka.	160 mm
Sirina gazista.	46 mm
Otvor za osovinu Ø	20 mm
Duzina glavcine.	58 mm
Temperatura	- 20 / + 80 °C
Standard	EN 12532
Tezina	0.771 kg
Tvrdoca omotaca	Shore A 63
Dinamicka nosivost.	300 kg
Staticka nosivost.	600 kg

Dimensions

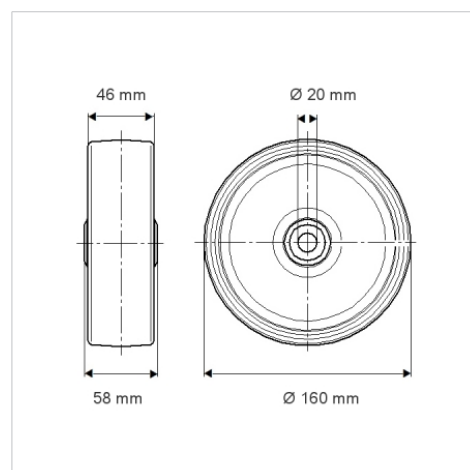

Advantages at a glance

Otpor okretanju	● ● ● ○ ○
Buka pri okretanju	● ● ● ● ●
trenje , habanje	● ● ● ○ ○
zastita od korozije	● ● ● ○ ○