

ELASTECH

UFC125X40@08X45

EAN 4031582422290

Wheel centre made of Polyamide, Tread: elastic-tyre, non-marking, with small threadguards, INOX precision ball bearing



BETTER MOBILITY. BETTER LIFE.



Picture may differ from original product

Technical Data

Wheel diameter	125 mm
Wheel width	40 mm
Axle Hole-Ø	8 mm
Hub length	45 mm
Temperature	- 20 / + 80 °C
Standard	EN 12532
Weight	0.502 kg
Hardness of tread	Shore A 64
Load capacity	250 kg
Load capacity (static)	500 kg

Dimensions

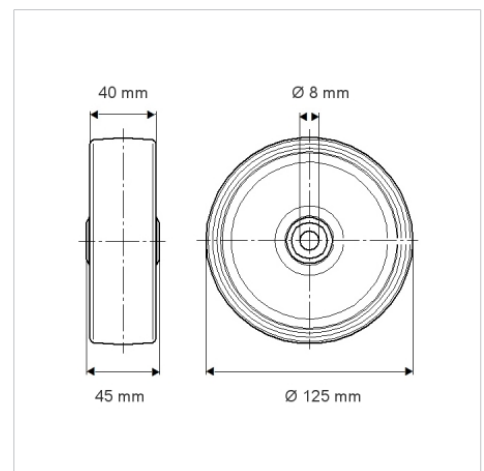

Advantages at a glance

Roll performance	● ● ● ○ ○
Movement noise	● ● ● ● ●
Attrition	● ● ● ○ ○
Corrosion resistance	● ● ● ○ ○