

ELASTECH

UFC125X40@08X45

EAN 4031582422290

Wheel centre made of Polyamide, Tread: elastic-tyre, non-marking, with small threadguards, INOX precision ball bearing



BETTER MOBILITY. BETTER LIFE.



Picture may differ from original product

기술 데이터

휠 직경	125 mm
휠 폭	40 mm
축 홀-Ø	8 mm
허브 길이	45 mm
온도	- 20 / + 80 °C
표준	EN 12532
무게	0.502 kg
트레드 경도	Shore A 64
동하중	250 kg
정지하중	500 kg

Dimensions

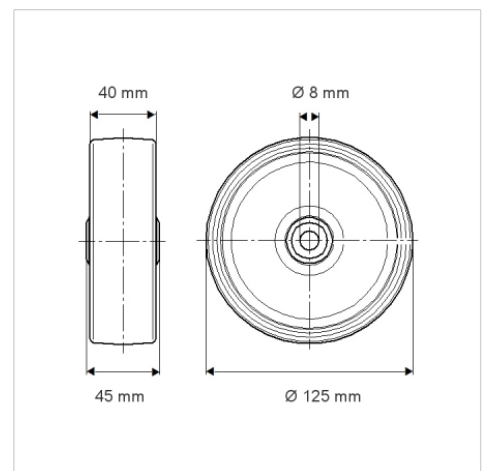

Advantages at a glance

롤 저항성	● ● ● ○ ○
이동 소음	● ● ● ● ●
마찰	● ● ● ○ ○
부식 방지	● ● ● ○ ○