

DURATECH

U00050x20-Ø8

EAN 4031582323450

폴리아미드로 만든 휠 중심, 평면 베어링



BETTER MOBILITY. BETTER LIFE.



Picture may differ from original product

기술 데이터

휠 직경	50 mm
휠 폭	20 mm
축 홀-Ø	8.1 mm
허브 길이	21.7 mm
온도	- 40 / + 80 °C
표준	EN 12530
무게	0.018 kg
트레드 경도	Shore D 75
동하중	55 kg
정지하중	110 kg

Dimensions

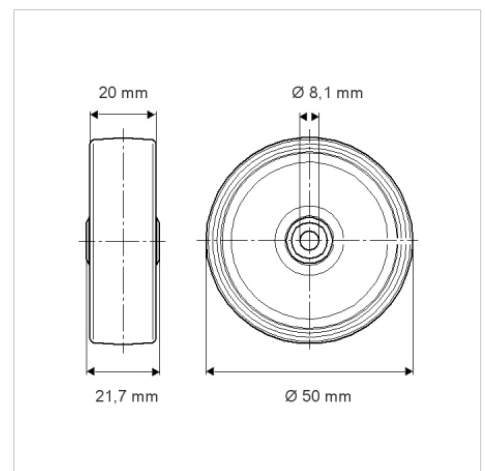

Advantages at a glance

롤 저항성	● ● ● ○ ○
이동 소음	● ● ● ○ ○
마찰	● ● ● ● ●
부식 방지	● ● ● ○ ○