

DURATECH

U00200x46-Ø20

EAN 4031582070132

폴리아미드로 만든 휠 중심, 평면 베어링



BETTER MOBILITY. BETTER LIFE.



Picture may differ from original product

기술 데이터

휠 직경	200 mm
휠 폭	46 mm
축 홀-Ø	20.1 mm
허브 길이	58 mm
온도	- 40 / + 80 °C
표준	EN 12532
무게	0.595 kg
트레드 경도	Shore D 75
동하중	600 kg
정지하중	1200 kg

Dimensions

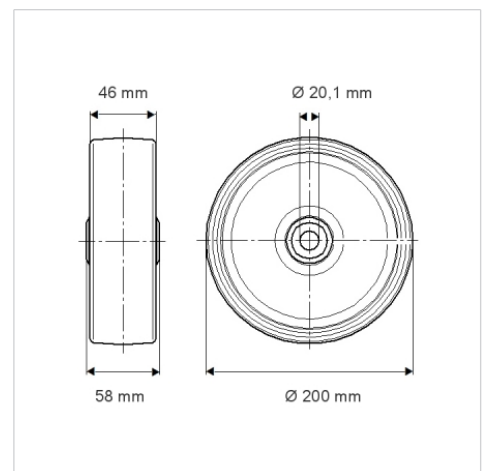

Advantages at a glance

롤 저항성	● ● ● ○ ○
이동 소음	● ● ● ○ ○
마찰	● ● ● ● ●
부식 방지	● ● ● ○ ○