

DURATECH

U00200x50-Ø20

EAN 4031582323474

Wheel centre made of Polyamide, plain bearing



BETTER MOBILITY. BETTER LIFE.



Picture may differ from original product

Technical Data

Wheel diameter	200 mm
Wheel width	50 mm
Axle Hole-Ø	20.1 mm
Hub length	58 mm
Temperature	- 40 / + 80 °C
Standard	EN 12532
Weight	0.793 kg
Hardness of tread	Shore D 75
Load capacity	800 kg
Load capacity (static)	1600 kg

Dimensions

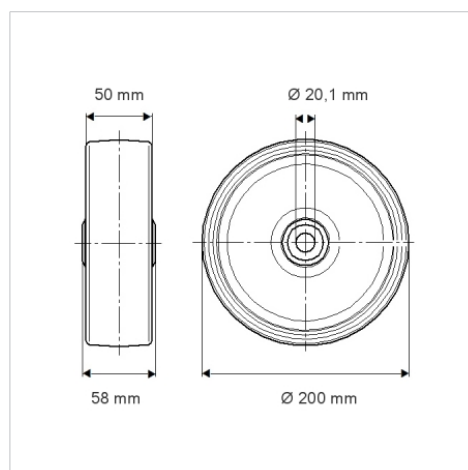

Advantages at a glance

Roll performance	● ● ● ○ ○
Movement noise	● ● ● ○ ○
Attrition	● ● ● ● ●
Corrosion resistance	● ● ● ○ ○