

DURATECH

UOR125x40-Ø12 HL 48,4

EAN 4031582323559

Wheel centre made of Polyamide, roller bearing



BETTER MOBILITY. BETTER LIFE.



Picture may differ from original product

Technical Data

Wheel diameter	125 mm
Wheel width	40 mm
Axle Hole-Ø	12 mm
Hub length	48.4 mm
Temperature	- 25 / + 80 °C
Standard	EN 12532
Weight	0.272 kg
Hardness of tread	Shore D 75
Load capacity	300 kg
Load capacity (static)	600 kg

Dimensions

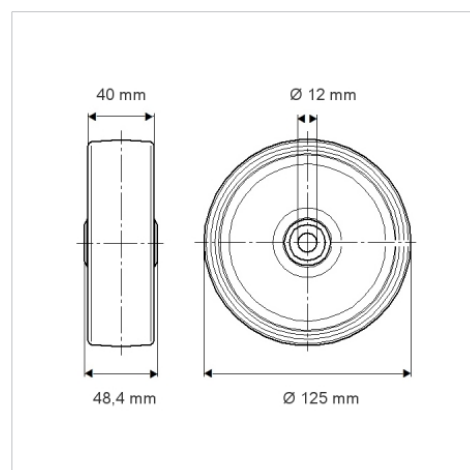

Advantages at a glance

Roll performance	● ● ● ○ ○
Movement noise	● ● ● ○ ○
Attrition	● ● ● ● ●
Corrosion resistance	● ● ● ○ ○