

DURATECH

UOR200x50-Ø20

EAN 4031582323573

Wheel center made of Polyamide, roller bearing



BETTER MOBILITY. BETTER LIFE.



Picture may differ from original product

Technical Data

Wheel diameter	200 mm
Wheel width	50 mm
Axle Hole-Ø	20 mm
Hub length	58 mm
Temperature	- 25 / + 80 °C
Standard	EN 12532
Weight	0.95 kg
Hardness of tread	Shore D 75
Load capacity (dynamic)	400 kg
Load capacity (static)	800 kg

Dimensions

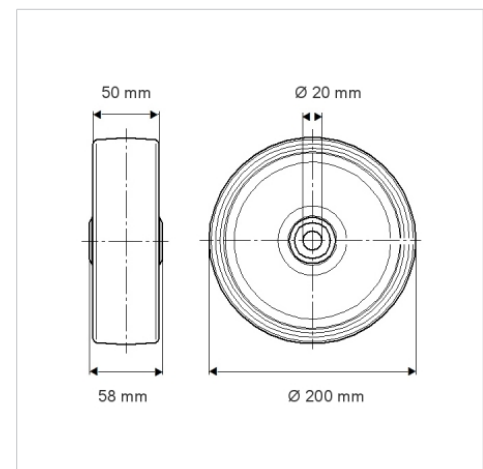

Advantages at a glance

Roll performance	● ● ● ○ ○
Movement noise	● ● ● ○ ○
Attrition	● ● ● ● ●
Corrosion resistance	● ● ● ○ ○