

MAXTECH

XSC125x32-Ø8

EAN 4031582323665

Srediste tocka napravljeno od poliamida, elektro provodno , omotac napravljen od poliuretana, sa radkapnama, precizni kuglicni lezaj , nerdjajuci celik

TENTE

BETTER MOBILITY. BETTER LIFE.



Picture may differ from original product

Tehnicki podaci

Precnik tocka.	125 mm
Sirina gazista.	32 mm
Otvor za osovinu Ø	8.3 mm
Duzina glavicine.	36.5 mm
Temperatura	- 25 / + 80 °C
Standard	EN 12530
Tezina	0.362 kg
Tvrdoca omotaca	Shore D 40
Dinamicka nosivost.	160 kg
Staticka nosivost.	320 kg

Dimensions

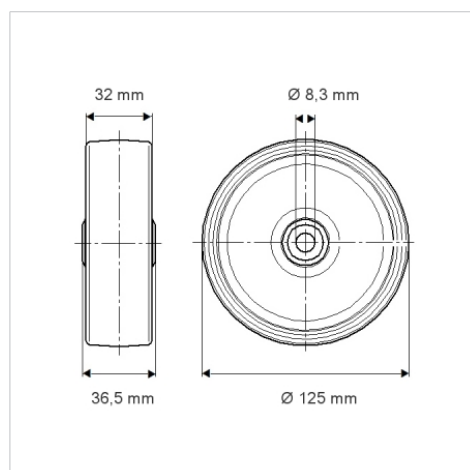

Advantages at a glance

Otpor okretanju	● ● ● ○ ○
Buka pri okretanju	● ● ● ○ ○
trenje , habanje	● ● ● ○ ○
zastita od korozije	● ● ● ○ ○