

MAXTECH

XSC150x32-Ø8

EAN 4031582323672

Jantă din poliamidă, electro-conductiv, suprafața de rulare din poliuretan, cu apărători, rulment de precizie INOX



BETTER MOBILITY. BETTER LIFE.



Picture may differ from original product

Date Tehnice

Diametrul roții	150 mm
Lățimea roții	32 mm
Alezaj butuc	8.3 mm
Lungime butuc	36.5 mm
Temperatura	- 25 / + 80 °C
Standard	EN 12530
Greutate	0.45 kg
Rigiditatea suprafeței de rulare	Shore D 40
Sarcină dinamică	160 kg
Sarcină statică	320 kg

Dimensions

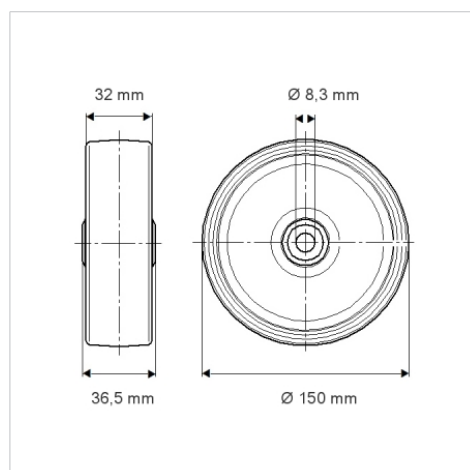

Advantages at a glance

Rezistență la rulare	● ● ● ○ ○
Zgomot de mișcare	● ● ● ○ ○
Uzare	● ● ● ○ ○
Protecție împotriva ruginii	● ● ● ○ ○